

TR Moon

Josep Ll. Xuclà

Aplique para baño IP44 (clase II) en perfil de aluminio extruido 40 x 40 mm.
Espejo circular integrado. Difusor de policarbonato opalizado.
Regulación de la luz con Dimmer integrado.

Wall lamp for bathroom IP44 (class II) in 40 x 40 mm extruded aluminum
profile. Integrated circular mirror. Opal polycarbonate diffuser.
Dimming light with integrated Dimmer.



TR 50 Moon 1300

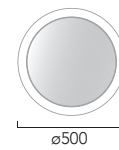

TR 70 Moon 1301

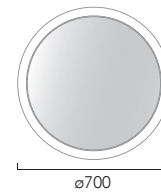

TR 100 Moon 1302

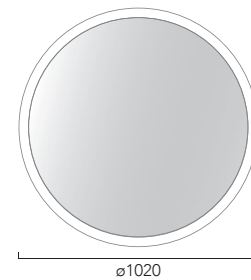

Luz / light

1300 - LED 16W 847lm

1301 - LED 16W 847lm

1302 - LED 16W 847lm

200/240V 50/60Hz 2700K - 3000K - 4000K

Acabados / Finishes

Blanco / White

Negro / Black

Champagne

Custom RAL

Acabados especiales / Special finishes

Bronce / Bronze

Latón satinado / Brushed brass

Níquel satinado / Brushed nickel



Luz directa / Direct light



INSOLIT

c/ Cerignola 13, 08022 Barcelona
+34 932 507 640 • insolit@insolitbcn.com • insolitbcn.com

1300

TR 50 Moon



Aplique para baño IP44 (clase II) en perfil de aluminio extruido 40 x 40 mm. Espejo circular integrado. Difusor de policarbonato opalizado. Regulación de la luz con Dimmer integrado.

Wall lamp for bathroom IP44 (class II) in 40 x 40 mm extruded aluminum profile. Integrated circular mirror. Opal polycarbonate diffuser. Dimming light with integrated Dimmer.

Código / Code	1300
Acabados / Finishes	01 Blanco / White 03 Negro / Black 04 Champagne 00 Custom RAL
Acabados especiales / Special Finishes	30 Bronce / Bronze 31 Latón satinado / Brushed brass 32 Níquel satinado / Brushed nickel
Luz / Light	38 LED 16W 847lm 2700K 35 LED 16W 847lm 3000K 41 LED 16W 847lm 4000K
Opcional / Optional	Espejo antivaho / Anti-fog mirror
Diseñador / Designer	Josep Ll. Xuclà
Año / Year	2017
Peso / Weight	5,5 kg
Material	Aluminio / Aluminium
Alimentación LED / LED tension	350mA
CRI	90
Difusor / Diffuser	Policarbonato / Polycarbonate
Dimensiones embalaje / Box Dimensions	73x71x5 cm

Instalación / Installation

En pared mediante tornillo y taco de expansión no incluidos de serie.

Wall installation with screws and an-chors (not included).

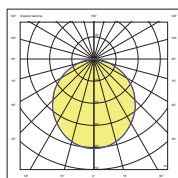
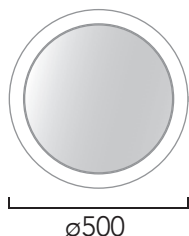

Luz directa / Direct Light



Fotometrías completas disponibles en
Full photometrics on: www.insolitbcn.com

Fabricado según normativa EN60598-1 y regulaciones pertinentes.

Manufactured according EN60598-1 normative and relevant regulations.

TR 50 Moon

Josep Ll. Xuclà

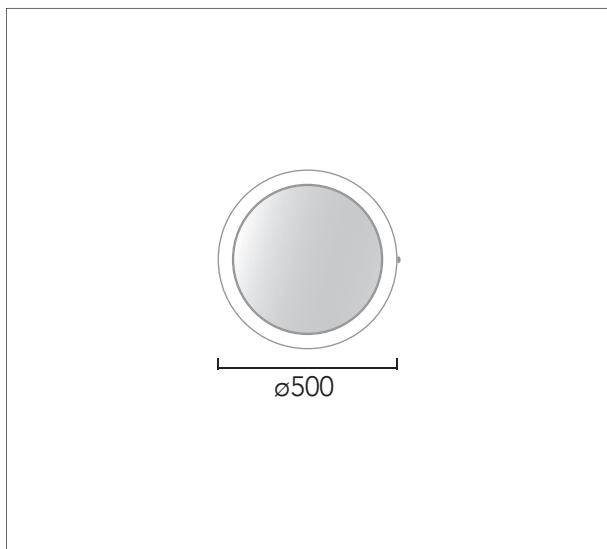

INSOLIT

c/ Cerignola, 13
08022 Barcelona
+34 932 507 640
insolit@insolitbcn.com
insolitbcn.com

TR 50 Moon

Josep Ll. Xuclà



1300XX01

Instrucciones de montaje

Installation instructions

INSOLIT

Instalación y conexión / Installation and Connection

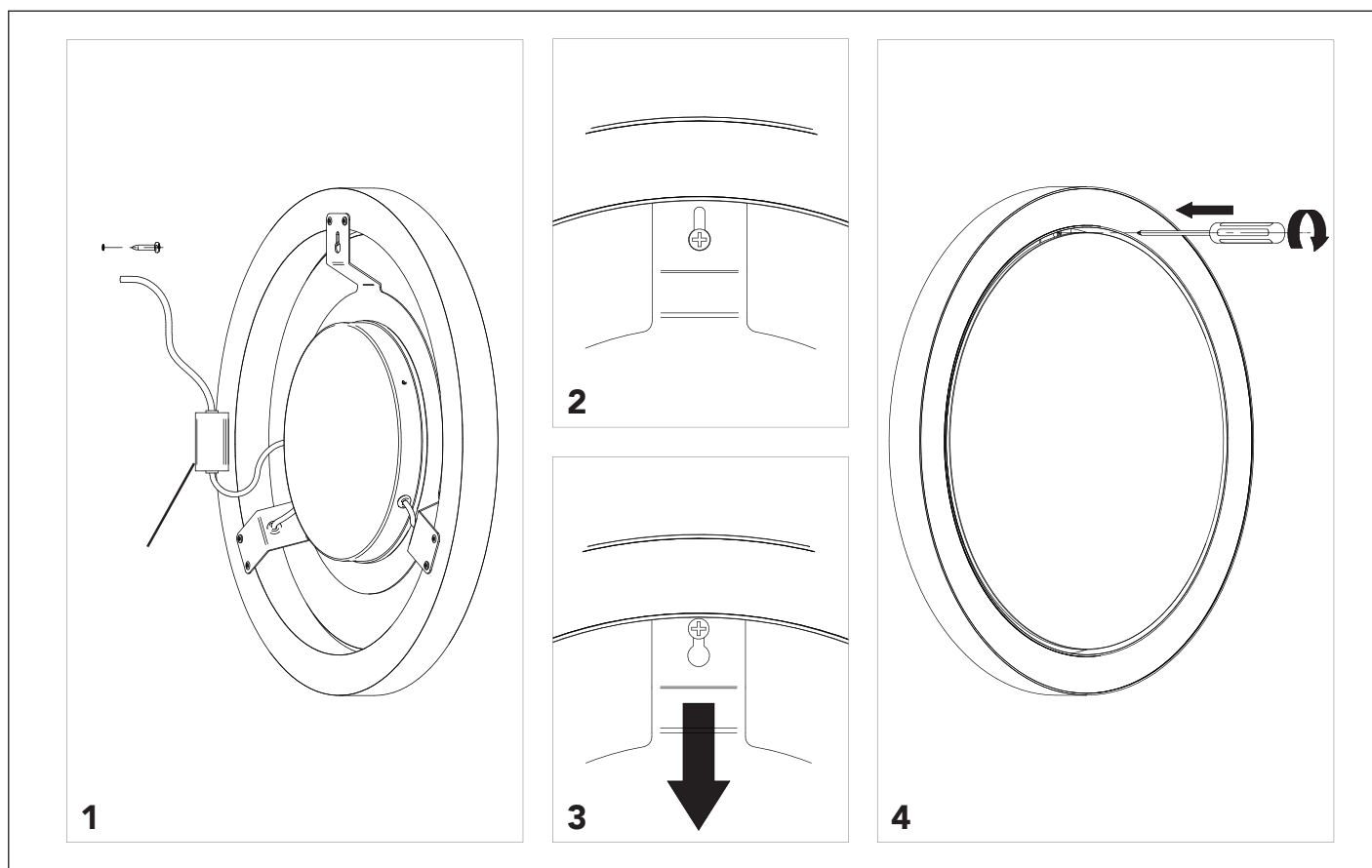

1301

TR 70 Moon



Aplique para baño IP44 (clase II) en perfil de aluminio extruido 40 x 40 mm. Espejo circular integrado. Difusor de policarbonato opalizado. Regulación de la luz con Dimmer integrado.

Wall lamp for bathroom IP44 (class II) in 40 x 40 mm extruded aluminum profile. Integrated circular mirror. Opal polycarbonate diffuser. Dimming light with integrated Dimmer.

Código / Code	1301
Acabados / Finishes	01 Blanco / White 03 Negro / Black 04 Champagne 00 Custom RAL
Acabados especiales / Special Finishes	30 Bronce / Bronze 31 Latón satinado / Brushed brass 32 Níquel satinado / Brushed nickel
Luz / Light	38 LED 24W 1270lm 2700K 35 LED 24W 1270lm 3000K 41 LED 24W 1270lm 4000K
Opcional / Optional	Espejo antivaho / Anti-fog mirror
Diseñador / Designer	Josep Ll. Xuclà
Año / Year	2017
Peso / Weight	9,25 kg
Material	Aluminio / Aluminium
Alimentación LED / LED tension	350mA
CRI	90
Difusor / Diffuser	Policarbonato / Polycarbonate
Dimensiones embalaje / Box Dimensions	73x71x5 cm

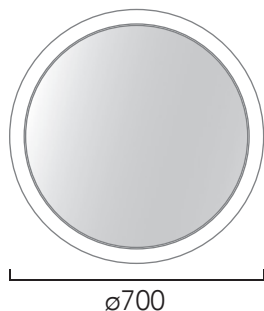

Instalación / Installation

En pared mediante tornillo y taco de expansión no incluidos de serie.

Wall installation with screws and an-chors (not included).



Luz directa / Direct Light

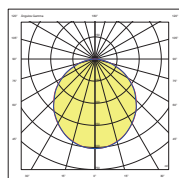

Fotometrías completas disponibles en Full photometrics on: www.insolitbcn.com

Fabricado según normativa EN60598-1 y regulaciones pertinentes.

Manufactured according EN60598-1 normative and relevant regulations.

TR 70 Moon

Josep Ll. Xuclà

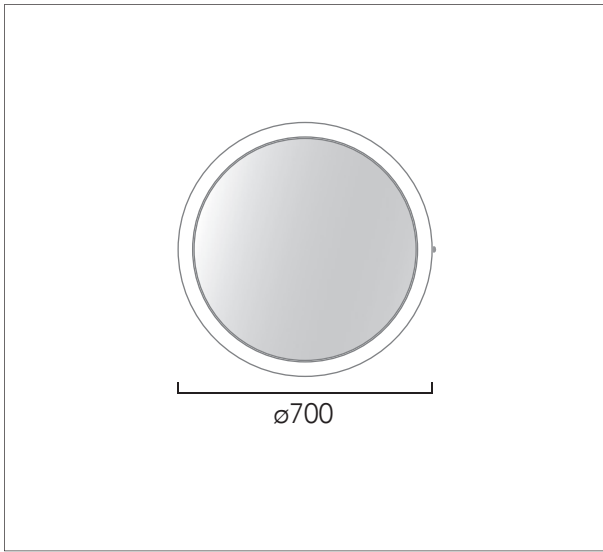

INSOLIT

c/ Cerignola, 13
08022 Barcelona
+34 932 507 640
insolit@insolitbcn.com
insolitbcn.com

TR 70 Moon

Josep Ll. Xuclà



1301XX01

Instrucciones de montaje
Installation instructions

INSOLIT

Instalación y conexión / Installation and Connection

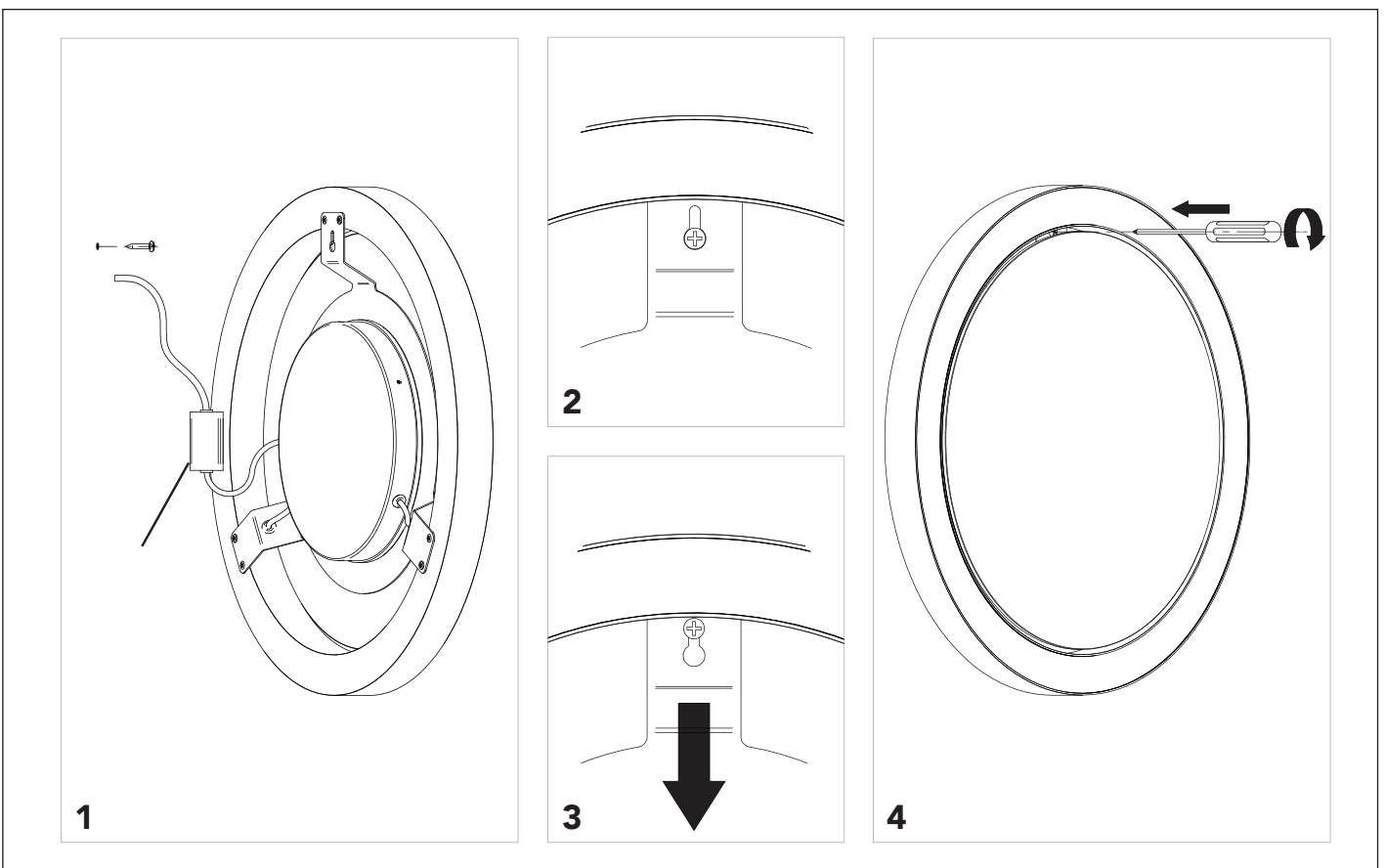

1302

TR 100 Moon



Aplique para baño IP44 (clase II) en perfil de aluminio extruido 40 x 40 mm. Espejo circular integrado. Difusor de policarbonato opalizado. Regulación de la luz con Dimmer integrado.

Wall lamp for bathroom IP44 (class II) in 40 x 40 mm extruded aluminum profile. Integrated circular mirror. Opal polycarbonate diffuser. Dimming light with integrated Dimmer.

Código / Code	1302
Acabados / Finishes	01 Blanco / White 03 Negro / Black 04 Champagne 00 Custom RAL
Acabados especiales / Special Finishes	30 Bronce / Bronze 31 Latón satinado / Brushed brass 32 Níquel satinado / Brushed nickel
Luz / Light	38 LED 35W 1905lm 2700K 35 LED 35W 1905lm 3000K 41 LED 35W 1905lm 4000K
Opcional / Optional	Espejo antivaho / Anti-fog mirror
Diseñador / Designer	Josep Ll. Xuclà
Año / Year	2017
Peso / Weight	17 kg
Material	Aluminio / Aluminium
Alimentación LED / LED tension	350mA
CRI	90
Difusor / Diffuser	Policarbonato / Polycarbonate
Dimensiones embalaje / Box Dimensions	73x73x6 cm

Instalación / Installation

En pared mediante tornillo y taco de expansión no incluidos de serie.

Wall installation with screws and an-chors (not included).

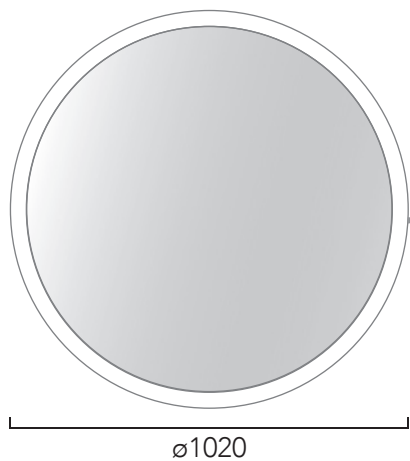

Luz directa / Direct Light

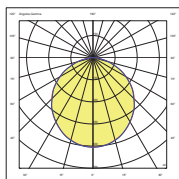

Fotometrías completas disponibles en Full photometrics on: www.insolitbcn.com

Fabricado según normativa EN60598-1 y regulaciones pertinentes.

Manufactured according EN60598-1 normative and relevant regulations.

TR 100 Moon

Josep Ll. Xuclà

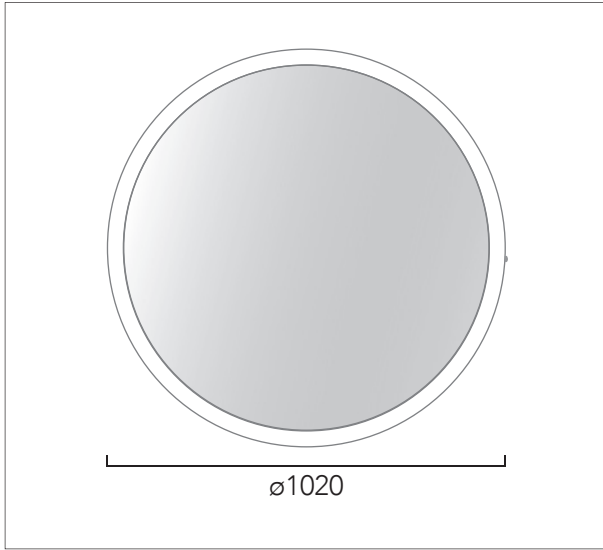

INSOLIT

c/ Cerignola, 13
08022 Barcelona
+34 932 507 640
insolit@insolitbcn.com
insolitbcn.com

TR 100 Moon

Josep Ll. Xuclà



1302XX01

Instrucciones de montaje
Installation instructions

INSOLIT

Instalación y conexión / Installation and Connection

