

Nassau 537B

NASSAU COLLECTION:

Nassau 533, Nassau 533M, Nassau
533N, Nassau 534, Nassau 534N,
Nassau 537B, Nassau 537, Trolley 536,

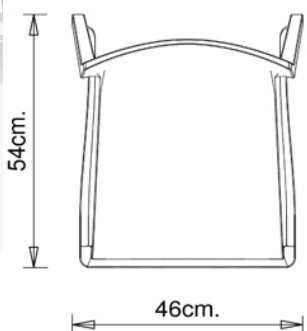
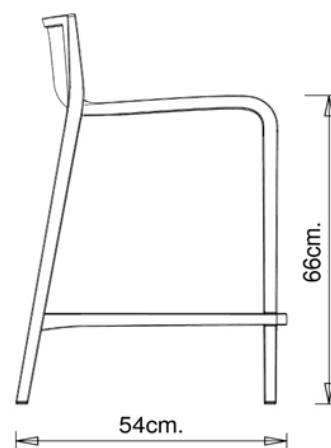
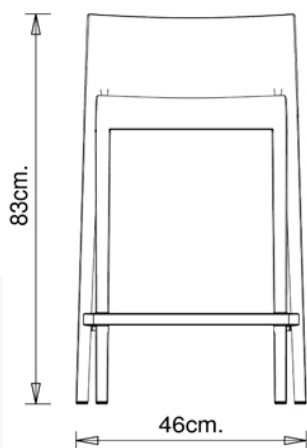

Monobloc barstool in polypropylene made using the injected air-moulding technology. Version with seat-height H 66 cm.

STACKABLE

5

WEIGHT

4,6 Kg

PACK

0,31 m³

PIECES PER BOX

2

FINISHES SEATING

PP POLYPROPYLENE



NCS S0500-N
Pure white

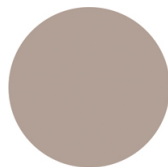

NCS S4005-Y50R
Turtle-dove



NCS S7502-B
Anthracite grey



NCS S9000-N
Jet black

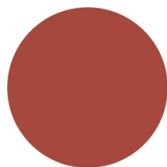

NCS S4040-R
Marsala

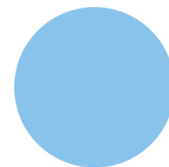

PANTONE 283 C
Sky blue
(Available while
stocks last)

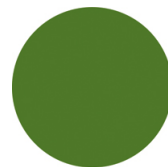

RAL 6010 Grass
green
(Available while
stocks last)



NOTE

Shell in **olive green** is made of **100% recycled polypropylene** from industrial waste.

USES

coffee & restaurants, entertainment, retail, outdoor,