

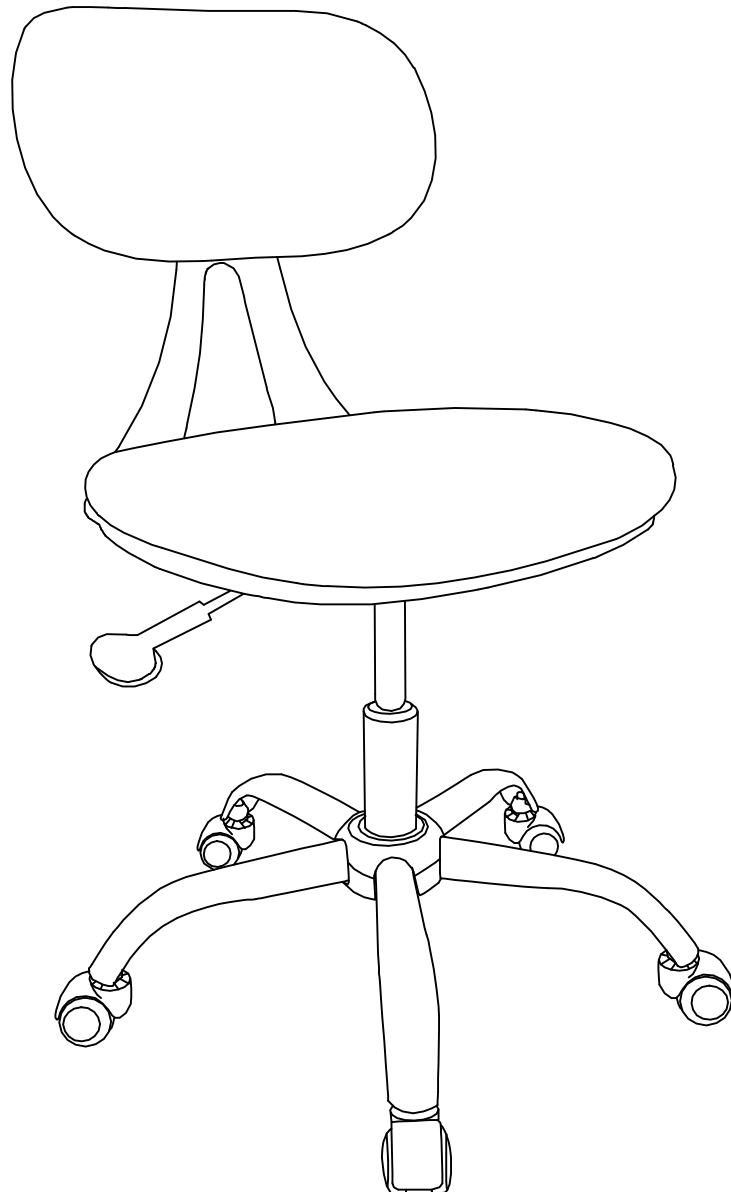

LIFETIME
KIDSROOMS

Art: 70953
70955
70957
70959

Samlevejledning
Assembly Instructions
Bauanleitung
Montage handleiding
Notice de montage
Istruzioni di montaggio



VIGTIGT! IMPORTANT! WICHTIG! BELANGRIJK! IMPORTANT! IMPORTANTE!

- DK Før du starter. Læs venligst denne instruktion grundigt igennem og opbevar denne til evt senere brug. Sørg for at plastikposer ikke kommer i små børns hænder og vær sikker på, at der ikke er små børn i nærheden, under montagen, da der er små dele i pakken.
- UK Before you start. Please read instructions carefully and retain for future reference. Please dispose carefully of packing materials. Keep plastic bags away from young children. Ensure young children are kept clear during assembly as this pack contains small parts.
- D Bevor Sie anfangen lesen Sie bitte die Bauanleitung sorgfältig durch und bewahren Sie diese Anleitung auf. Versichern Sie sich, dass keine kleinen Kinder in der Nähe sind während Sie aufbauen weil die Verpackung kleinste Teile beinhaltet. Plastic Verpackungsteile daher bitte gleich wegwerfen.
- NL Voordat u begint, lees a.u.b. de montage-instructie aandachtig door en bewaar deze zorgvuldig. Plastic verpakkingsmateriaal weghouden bij jonge kinderen. Wees er zeker van dat tijdens het monteren van het bed de kinderen op veilige afstand zijn omdat de verpakking kleine onderdelen bevat.
- F Avant de commencer. Veuillez lire cette notice soigneusement et pensez à la garder pour une utilisation ultérieure. Veuillez à ne pas laisser les sachets plastiques accessibles aux enfants, et à éloigner les enfants pendant le montage car présence de petits objets dans les colis.
- I Prima di iniziare. Si prega di leggere attentamente le istruzioni e di conservarle per un uso successivo. Tenere lontano dalla portata dei bambini il pacchetto perché contiene piccole parti di assemblaggio e fare attenzione a non lasciarle in giro.

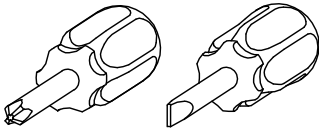
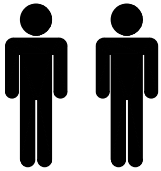

Art: 70953 / 70955 / 70957 / 70959

Colli: 1

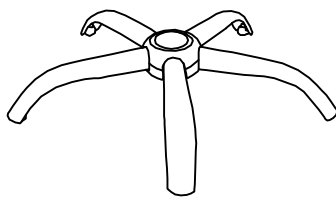
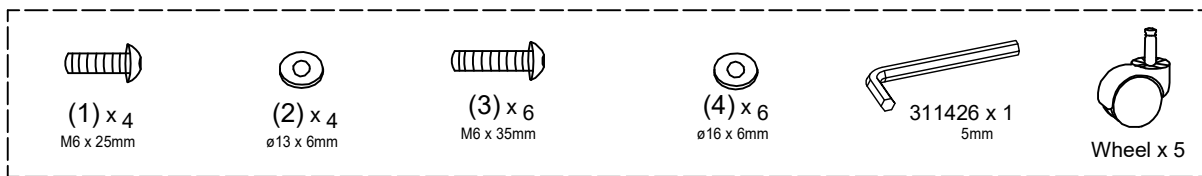

Base X 1



Gas Column X 1

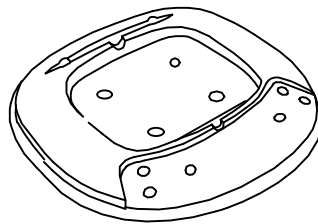

Seat X 1

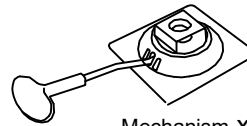

Mechanism X 1

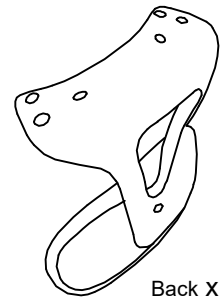

Back X 1

1

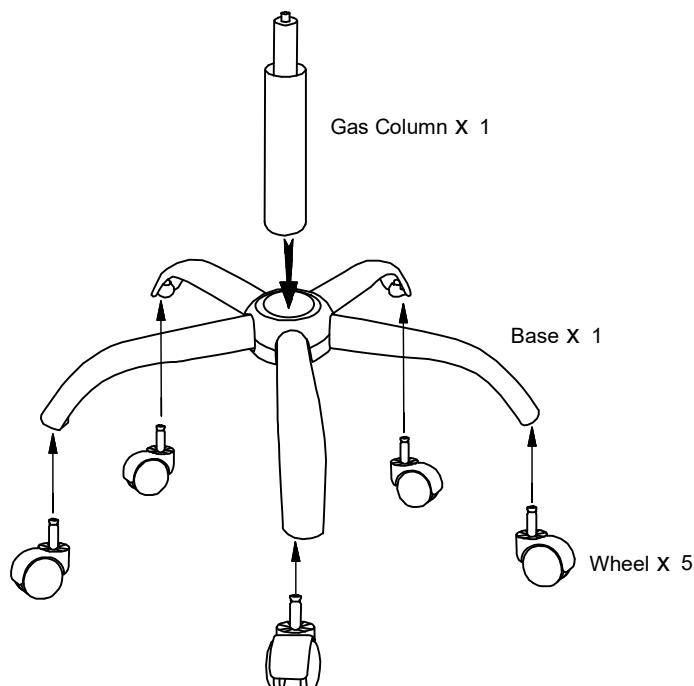

2



(1) x 4
M6 x 25mm



(2) x 4
ø13 x 6mm

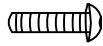

(3) x 6
M6 x 35mm



(4) x 6
ø16 x 6mm



311426 x 1
5mm

B

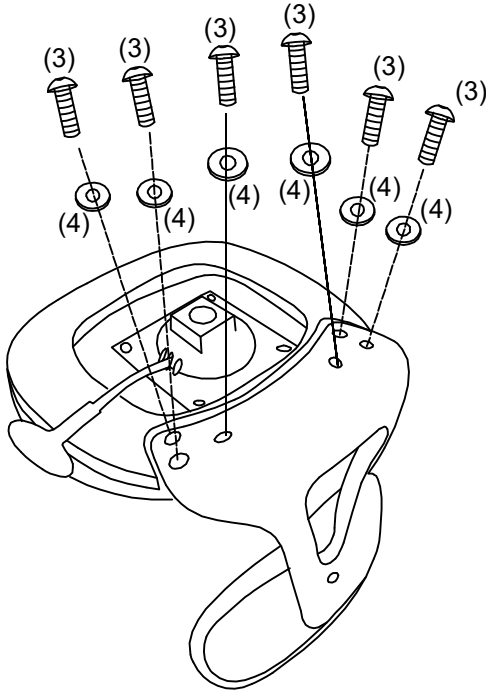

A

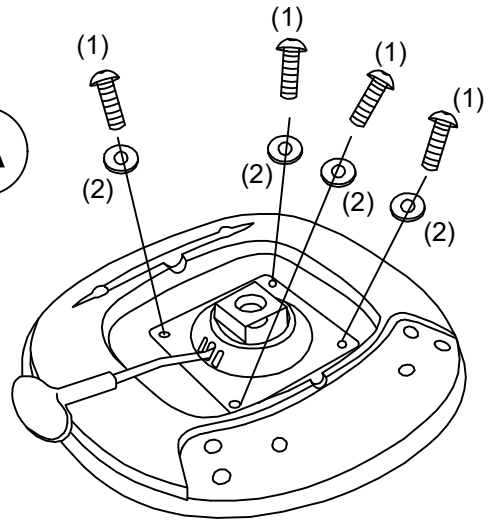

C

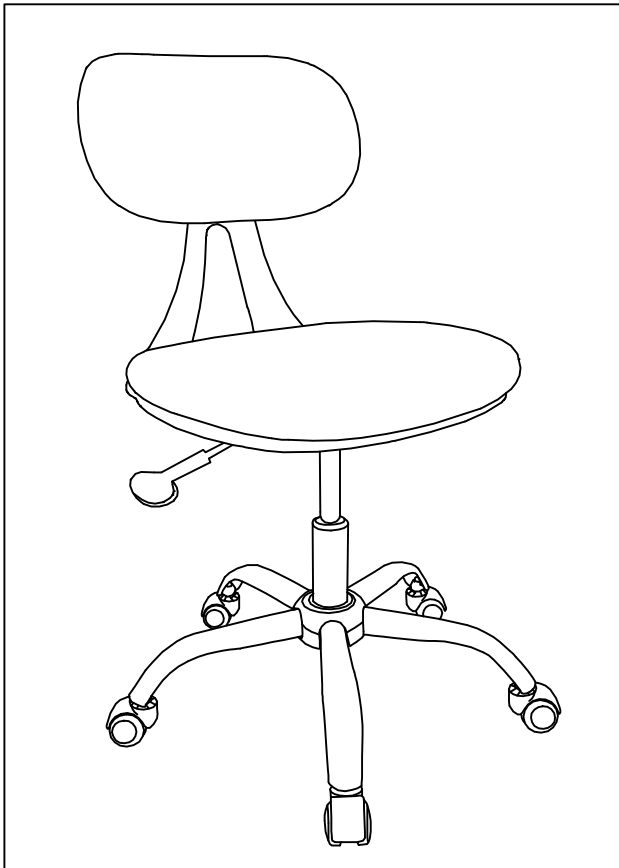
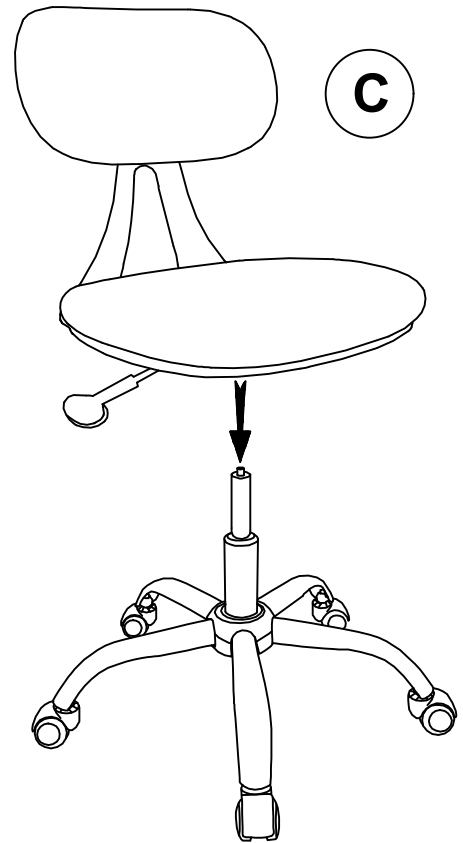

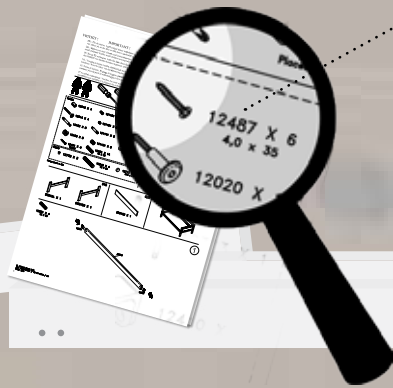
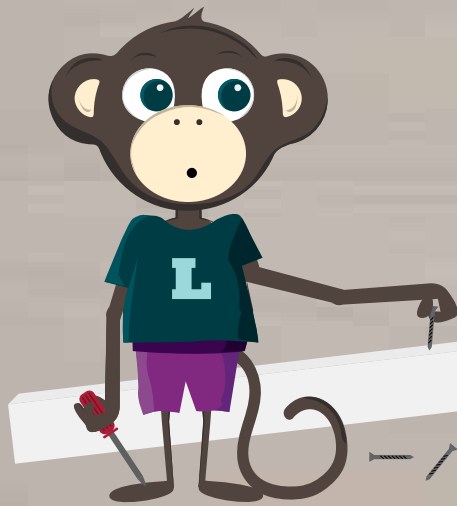

ATTENTION!
"Please let us know what you need.
If there are missing parts,
then give us the specific number
on which part - see page 2."



DK LIFETIME BESTRÆBER SIG ALTID EFTER AT LEVERE DEN BEDSTE KVALITET. SKULLE DER MOD FORVENTNING OPSTÅ EN REKLAMATION, BEDES DE VENLIGST UDFYLDE DENNE BLANKET, OG AFLEVERE DEN TIL LIFETIME FORHANDLEREN / **UK** LIFETIME ALWAYS STRIVES TO PROVIDE THE BEST QUALITY. IN THE UNLIKELY SITUATION OF A CLAIM, PLEASE FILL OUT THIS FORM AND HAND IT OVER TO THE LIFETIME DEALER WHERE YOU BOUGHT YOUR LIFETIME FURNITURE / **D** LIFETIME BEMÜHT SICH IMMER DIE BEST MÖGLICHE QUALITÄT ZU LIEFERN. SOLLTE GEGEN ALLER ERWARTUNG DENNOCH EIN GRUND FÜR EINE REKLAMATION ENTSTEHEN, FÜLLE BITTE FOLGENDES FORMULAR AUS UND REICHE DIES ZUSAMMEN MIT FOTOMATERIAL DEM LIFETIME HÄNDLER BEI DEM SIE DIE LIFETIME MÖBEL ERWORBEN HABEN / **NL** LIFETIME STREEFT ALTIJD NAAR DE BESTE KWALITEIT. MOCHT U EEN KLACHT HEBBEN, VULT U DAN ONDERSTAAND FORMULIER IN EN GEEF HET AAN DE LIFETIME DEALER WAAR U DE LIFETIME MEUBELEN HEEFT GEKOCHT / **IT** LIFETIME CERCA DI FORNIRE SEMPRE LA MIGLIORE QUALITA'. NELLA RARA EVENTUALITA' IN CUI SI PRESENTI UN RECLAMO, VI PREGHIAMO DI COMPILARE QUESTO MODULO E CONSEGNARLO AL VOSTRO RIVENDITORE LIFETIME / **F** LIFETIME S'EFFORCE TOUJOURS DE FOURNIR LA MEILLEURE QUALITE. DANS LA SITUATION PEU PROBABLE D'UNE REKLAMATION, MERCI DE REMPLIR CE FORMULAIRE ET DE LE REMETTRE AU REVENDEUR LIFETIME A QUI VOUS AVEZ ACHETE VOS MEUBLES LIFETIME.



NAME



DATE



ADDRESS



PHONE



MAIL



STORE



ARTICLE NO.

PROBLEM:

DESCRIPTION:

FAULTS IN LACQUER OR SURFACE TREATMENTS

FAULTS FROM PRODUCTION (REGARDLESS MATERIAL AS TREE, FABRICS ETC.)

MISSING OR WRONG PARTS INCLUDING FITTINGS

DAMAGED PART(S) INCLUDING TRANSPORT DAMAGES

OTHER CAUSE WHICH CAN NOT BE RELATED TO ABOVE



WWW.LIFETIMEKIDSROOMS.COM

M. Schack Engel A/S • Højervej 16 • 6280 • Højer • Denmark • +45 7478 2258