

a

emotional light

cambo collection

LED

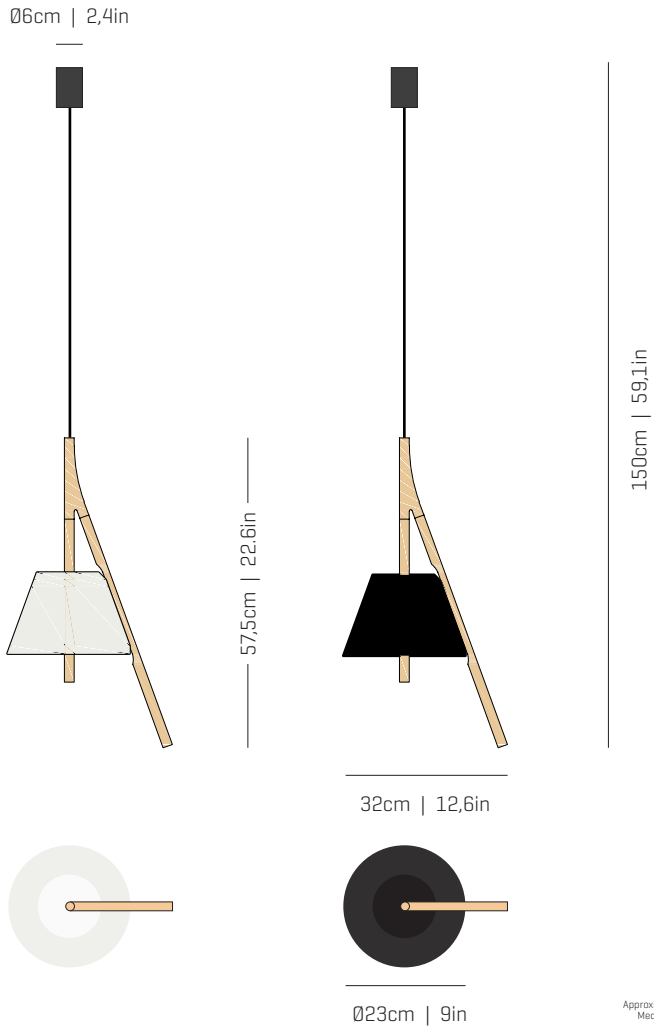

ref. CM204

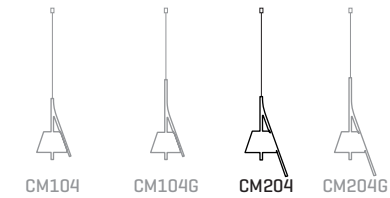

Approximate measurements
Medidas aproximadas

MATERIALS & COMPONENTS | MATERIALES & COMPONENTES

LAMP SHADE | TULIPA

Painted stainless steel | One color to choose
Acero inoxidable pintado | Un color a elegir

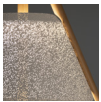

BL

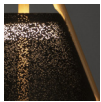

N

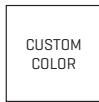

CUSTOM
COLOR

Beech wood | Madera de haya

Painted aluminum | Aluminio pintado

Built-in diffuser | Difusor incorporado

CANOPY AND CABLE

FLORÓN Y CABLE

Steel painted in matt black
Acero pintado en negro mate

Black cable

Cable negro

Standard: 150cm | 59,1in

Length/largo customizable

120V: 200cm | 78,7in

LIGHT SOURCE BUILT IN

FUENTE DE LUZ INCLUIDA

230V - 50Hz



7W 2700K 850lm built-in

Dimming system: PHASE CUT

This product contains
a light source of energy
efficiency class **D**
Este producto contiene una
fuente luminosa de la clase
de eficiencia energética **D**



120V - 60Hz



7W 2700K 850lm built-in

Dimming system: PHASE CONTROL & 0-10V

OTHER DATA | OTROS DATOS

NET WEIGHT

PESO NETO

1kg | 2,2lb

PACKAGING

EMBALAJE

31x32x73cm | 12,2x12,6x28,7 in

1,9kg | 4,2lb

ELECTRICAL FEATURES

CARACTERÍSTICAS ELÉCTRICAS



CERTIFICATIONS

CERTIFICACIONES



Cambo

ref. CM204

Suitable for indoor use, at 25°C

Apta para uso interior a temperatura ambiente de 25°C

Box contains | Contenido de la caja:

A - Lampshade | Tulipa [1]

B - Holding piece | Pieza de sujeción [1]

C - Security screws | Tornillos de seguridad [2]

D - Wall Plugs | Tacos [2]

E- Canopy | Florón [1]

F- Screws | Tornillos [2]

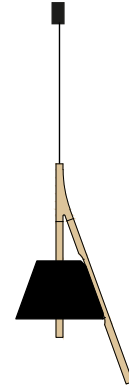

LED

PHASE CUT



This product contains a light source of energy efficiency class **D**
Este producto contiene una fuente luminosa de la clase de eficiencia energética **D**

UNPACKING INSTRUCTIONS: Due to the delicacy of the luminaire, it is recommended not to remove the packaging protection until the installation is complete.

INSTRUCCIONES DE DESEMBALAJE: Debido a la delicadeza de la luminaria se recomienda no retirar la protección del embalaje hasta tener terminada la instalación.

SAFETY NOTE: Switch off mains supply before commencing installation

INDICACIÓN DE SEGURIDAD: Desconecte la alimentación eléctrica antes de empezar con la instalación

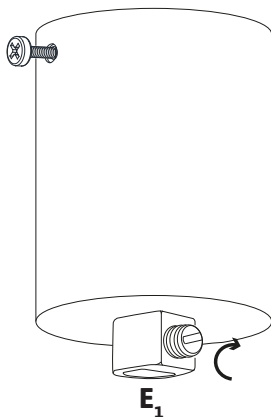
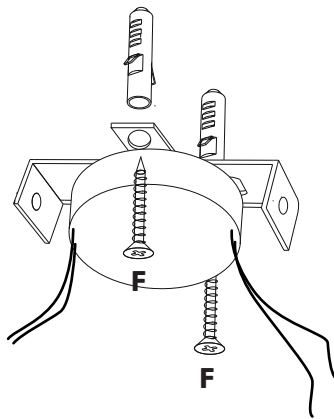

1

Drill the holes in the ceiling and fit the wall plugs into them.

Pass the electric cables to the interior and tighten the set screws [F].

Pass the electrical cable of the luminaire through the strain relief to make the electrical connection.

Realizar los agujeros en el techo y colocar los tacos.

Pasar los cables eléctricos al interior y apretar los tornillos de fijación [F].

Pase el cable eléctrico de la luminaria a través del antitirón [E₁] para realizar la conexión eléctrica.

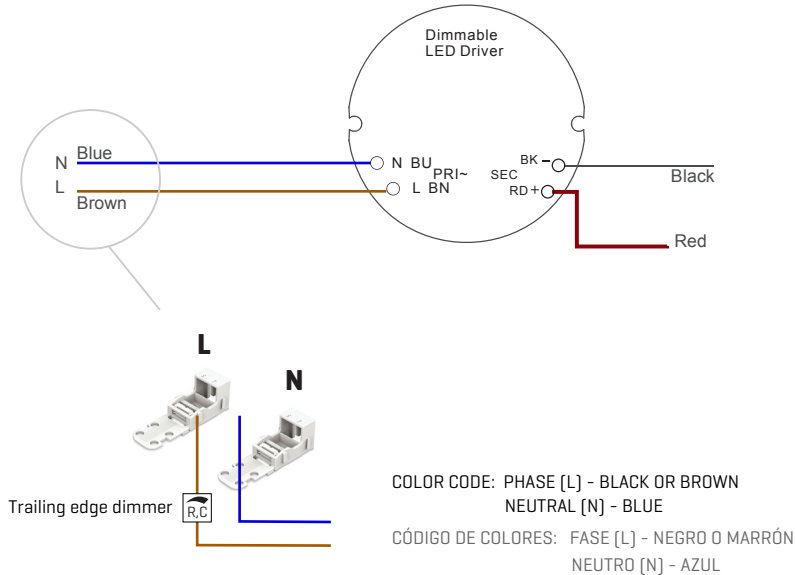

2

Do the electric connection in the terminal blocks, please following the code os letters and colors indicated.

For a correct connection is important stripping wires correctly with a distance between 8-12mm.

Hacer la conexión eléctrica en las fichas de conexiones, siguiendo el código de letras y colores indicado.

Para una correcta conexión es importante pelar los cables correctamente con una distancia entre 8-12mm.

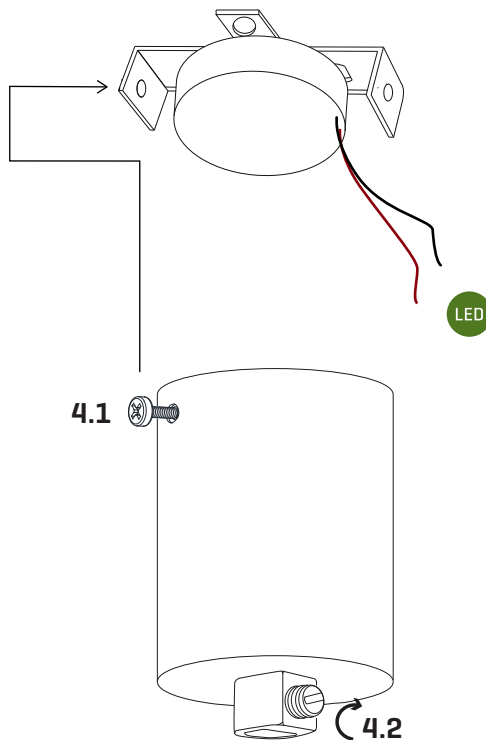

3

LED CONNECTION:

Once the light source is connected, proceed to connect the luminaire to the connection tabs, respecting the color code for low voltage:

RED WITH RED - POSITIVE

BLACK WITH BLACK - NEGATIVE

To do this, lift the free orange label and insert the cable marked with the base corresponding to the color you are connecting.

Finally, tighten the canopy screws located on both sides [3.1] and tighten the strain relief screw [3.2] without exerting too much pressure on the cable.

CONEXIÓN LED (luminaria):

Una vez tenga conectada la fuente de luz, proceda a conectar la luminaria a las fichas de conexión respetando el código de colores para baja tensión:

ROJO CON ROJO - POSITIVO

NEGRO CON NEGRO - NEGATIVO

Para ello levante la pestaña naranja libre e introduzca el cable marcado con la funda correspondiente al color que esté conectando.

Por último, apriete los tornillos del florón situados a ambos lados [3.1] y apriete sin realizar demasiada presión sobre el cable el tornillo del antitirón [3.2].