

ESPECIFICACIONES TÉCNICAS / ACABADOS
TECHNICAL DATA / FINISHED

TAGOMAGO / 6628

Jordi Jané

BL

Ø 225

H 311

S 269

1 x E14 | 5 W. | 462 lumens x1 | 3000 K |  | EEI: A+

 | IP55 |  | 

DESCRIPCIÓN
DESCRIPTION

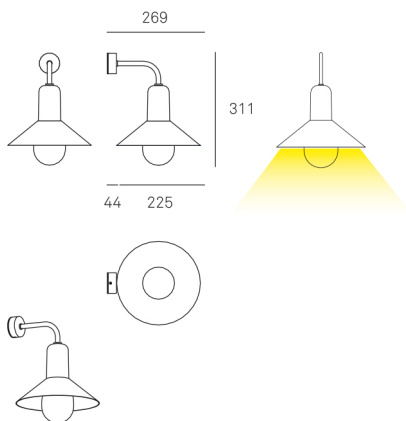
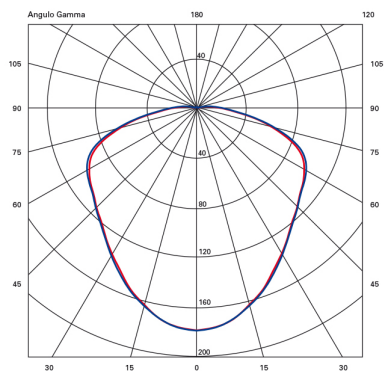

COMENTARIOS / COMMENTS