

SISMA floor lamp

Matteo Ugolini design

year 2015

TECHNICAL SHEET - HP112 1T INT

STRUCTURE "A"

material	costruction site's ribbed rebar	
colour	natural	

ELECTRICAL CABLE "C"

material	fabric cable	
colour	black woven	

ELECTRICAL SYSTEM

socket	E27
source	max 3x77w
energy class	from E to A++





PACKAGING

nr. of collis	1
net weight/kg	9,7
gross weight/kg	17
packaging/cm	68x67x173

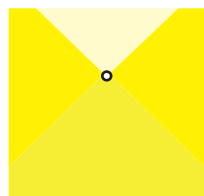
EMISSION OF LIGHT

one-directional



	direct
	filtered
	indirect
	none

CERTIFICATION

IEC	60598-1:2008
EN	60598-1:2008 + A11:2009



IP rate	IP20
bulb	optional



code **700L**
decorative bulb
E27 - 25w - ≤ 60 lumen
class E

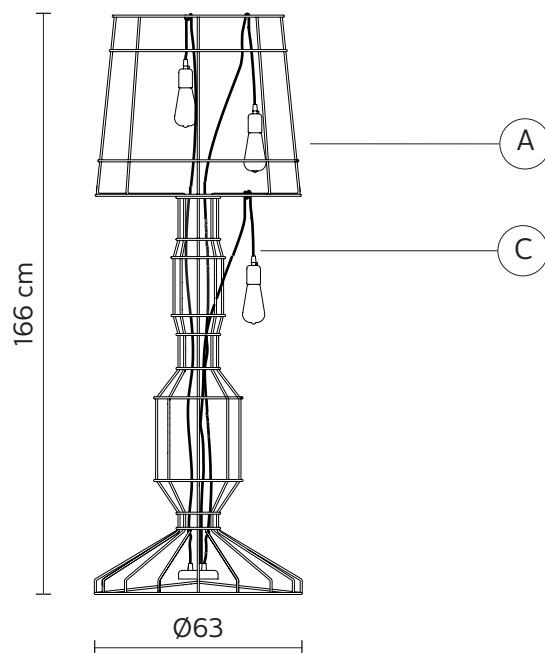

COLLECTION

available also as: suspension



HP112 1B INT