

24KARATI

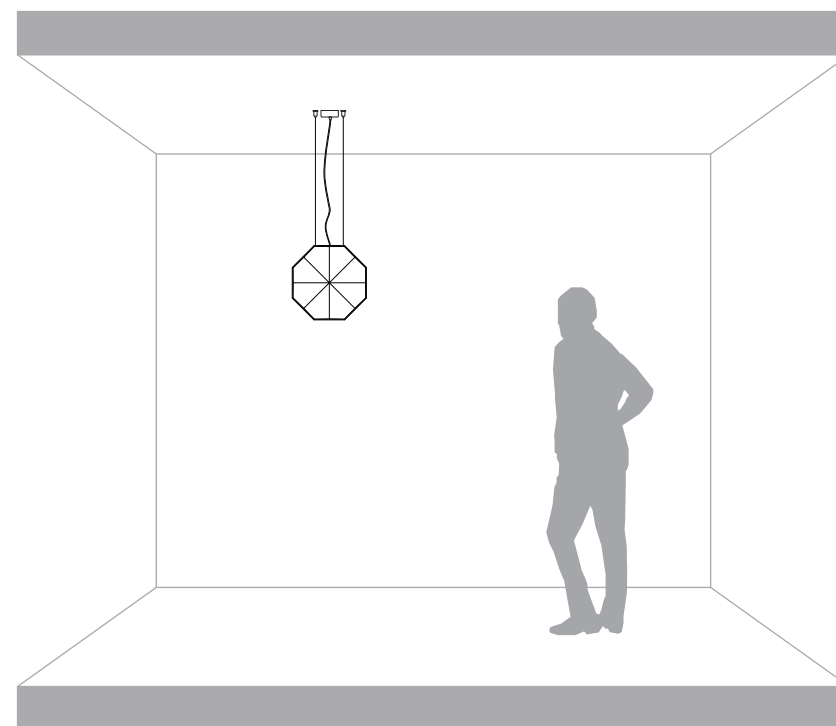

SE113 1G INT
SE113 1F INT
SE113 1B INT

220-240 V.
max 1x70W - E27



Karman srl

Via A. Grandi, San Martino del piano, 61034 Fossombrone (PU), Italy - p.iva 02175640412 tel +39 0721 71 5042 r.a fax +39 0721 716640 - www.karmanitalia.it

C - 01

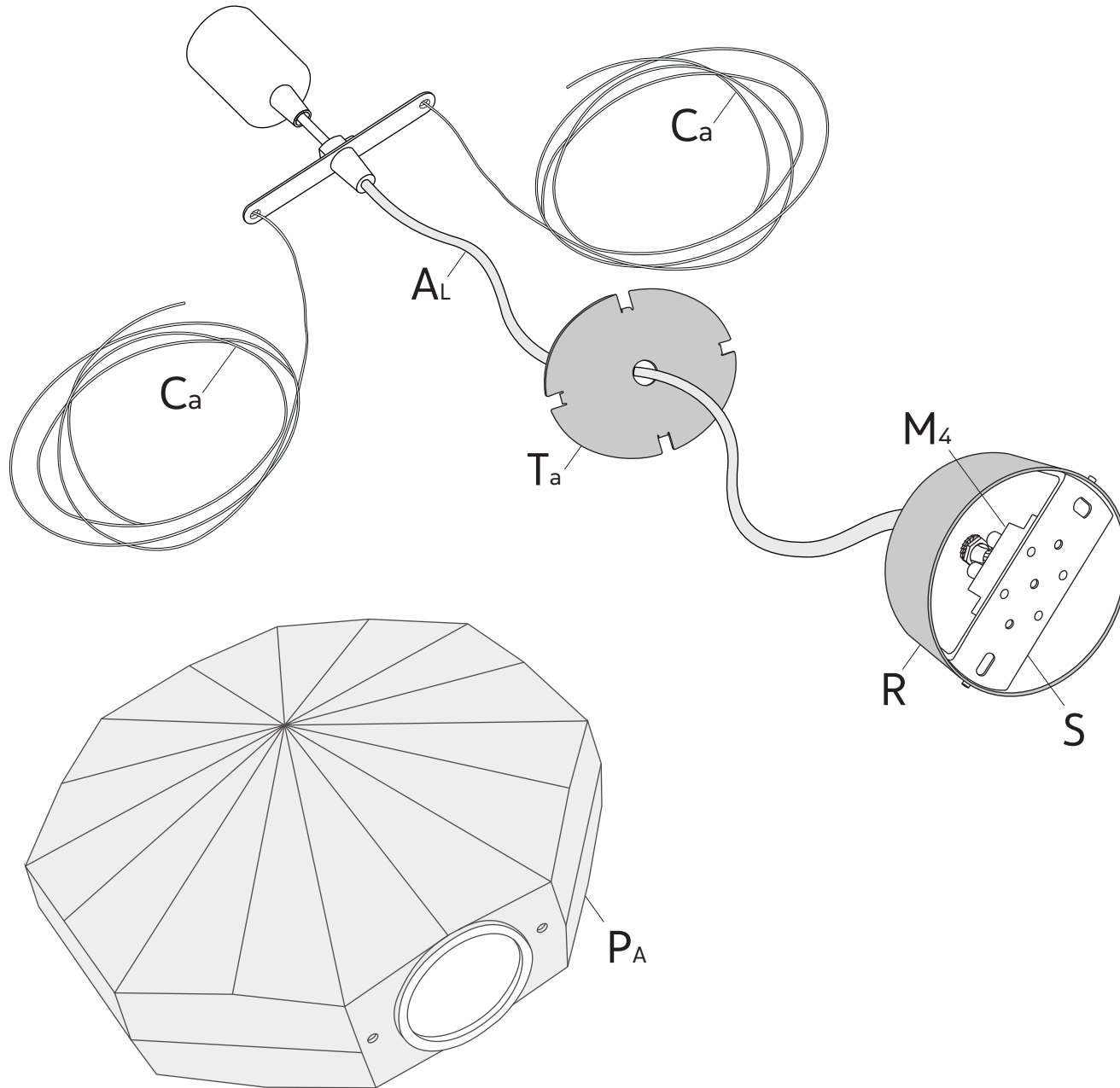

2x **B**

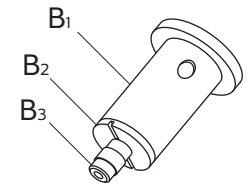

4x **F**

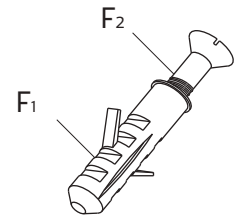

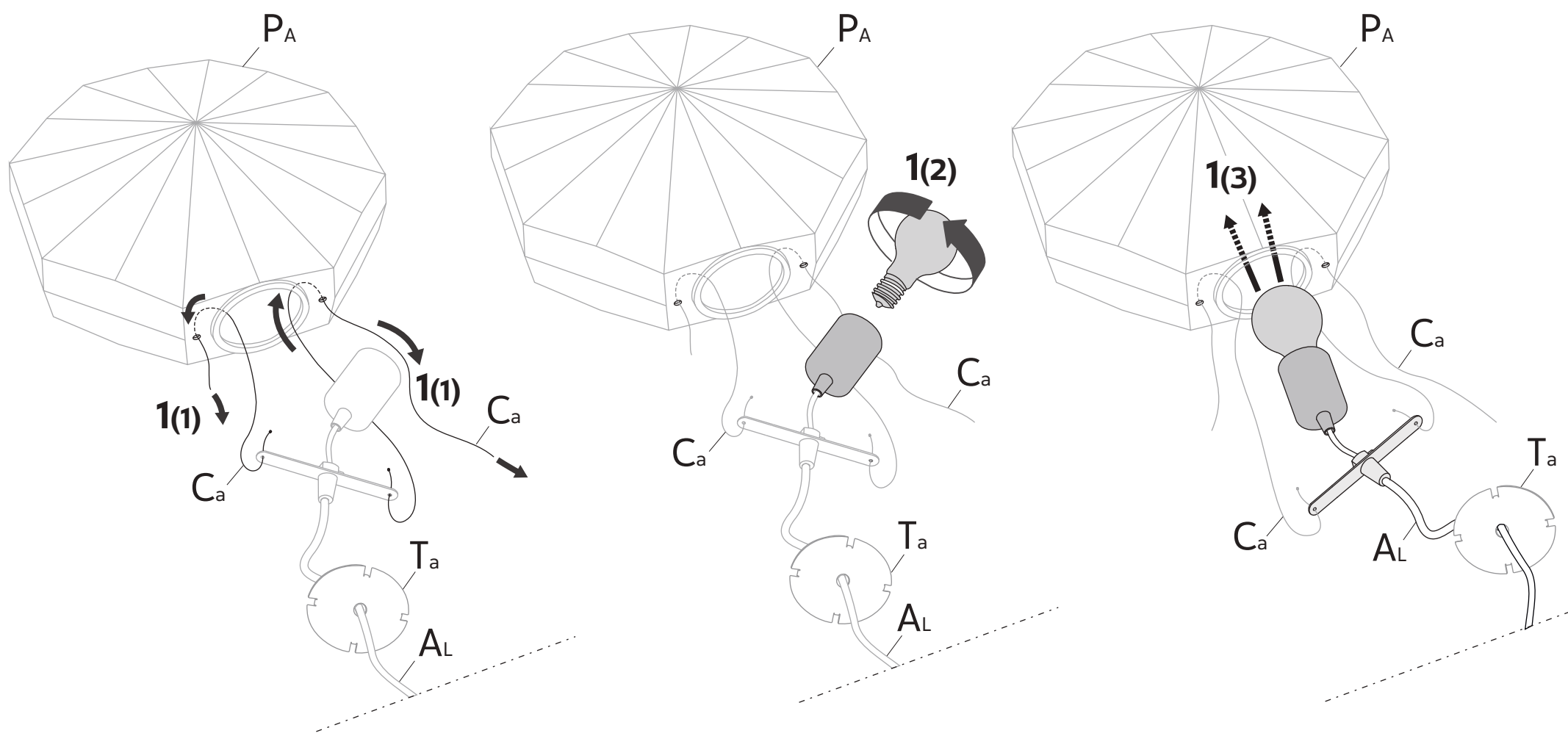

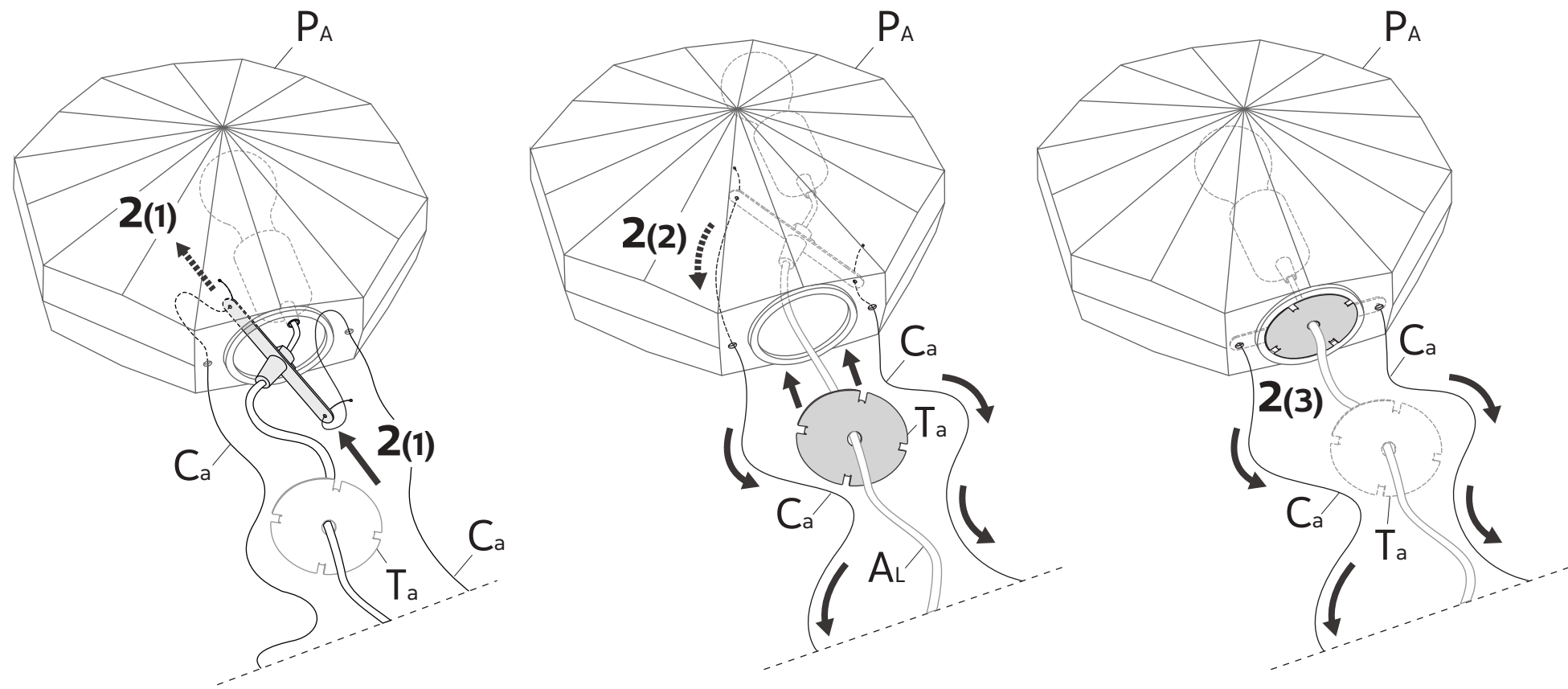

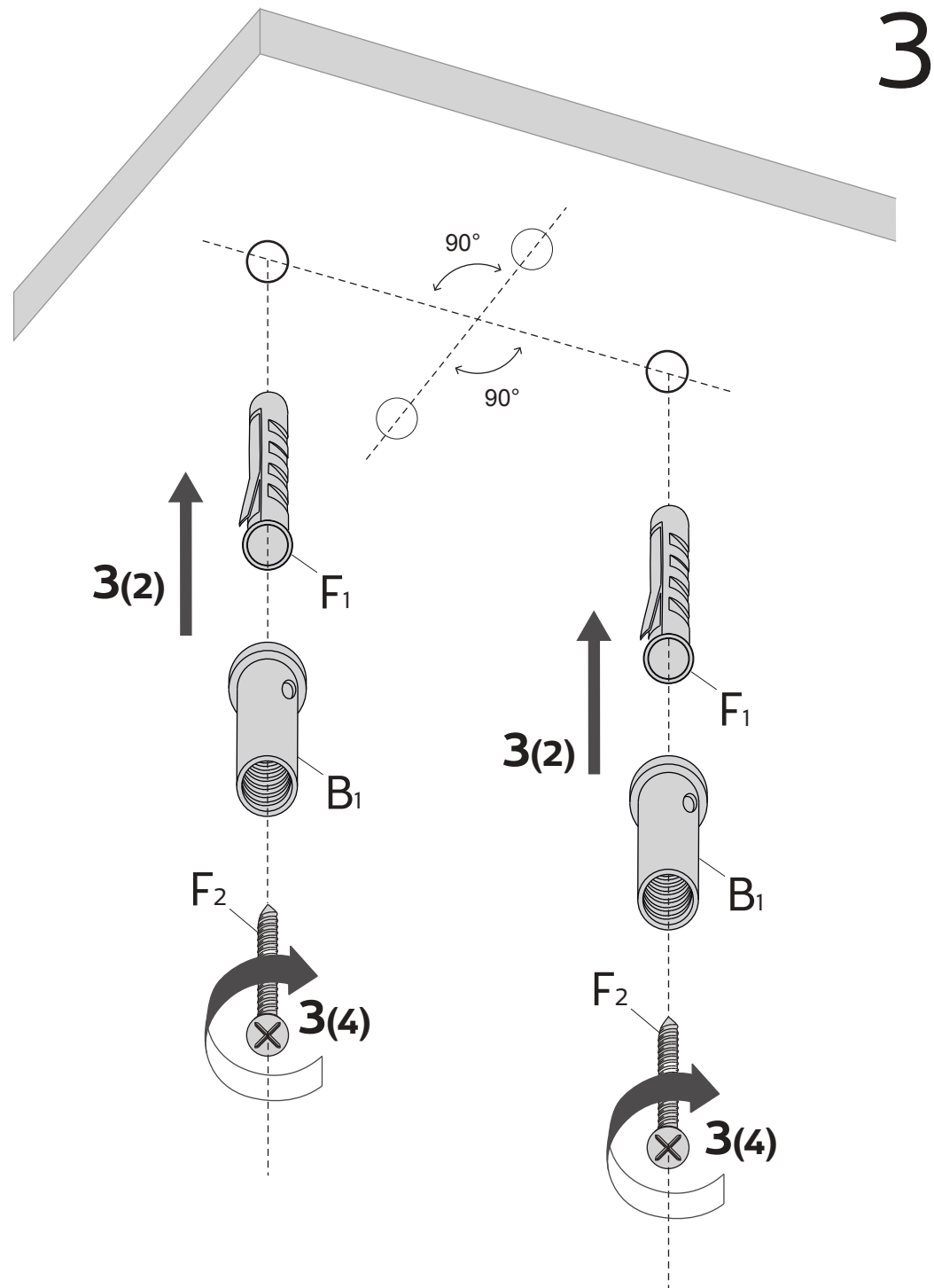
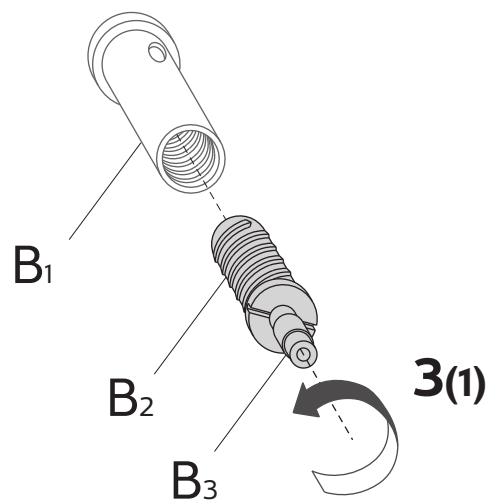
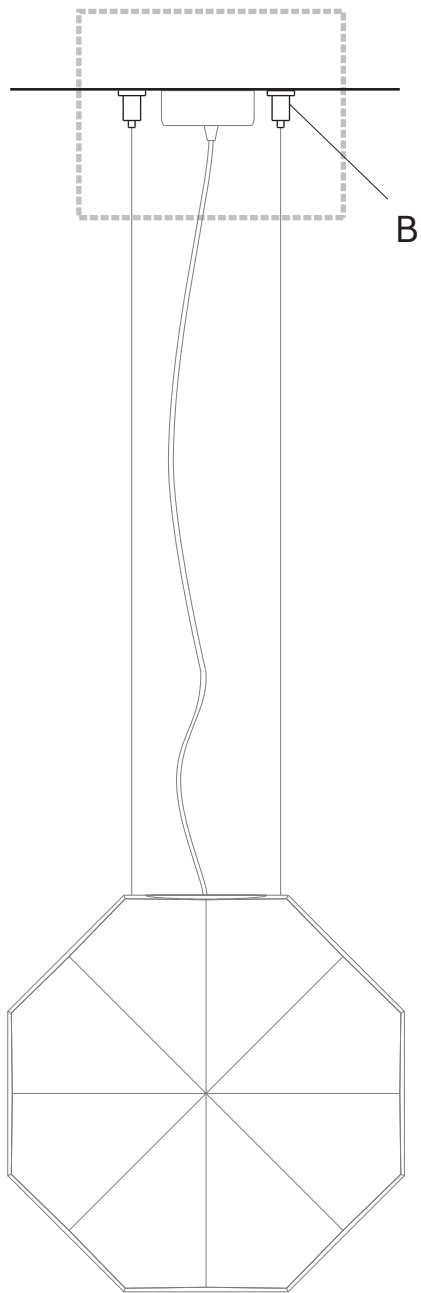

3

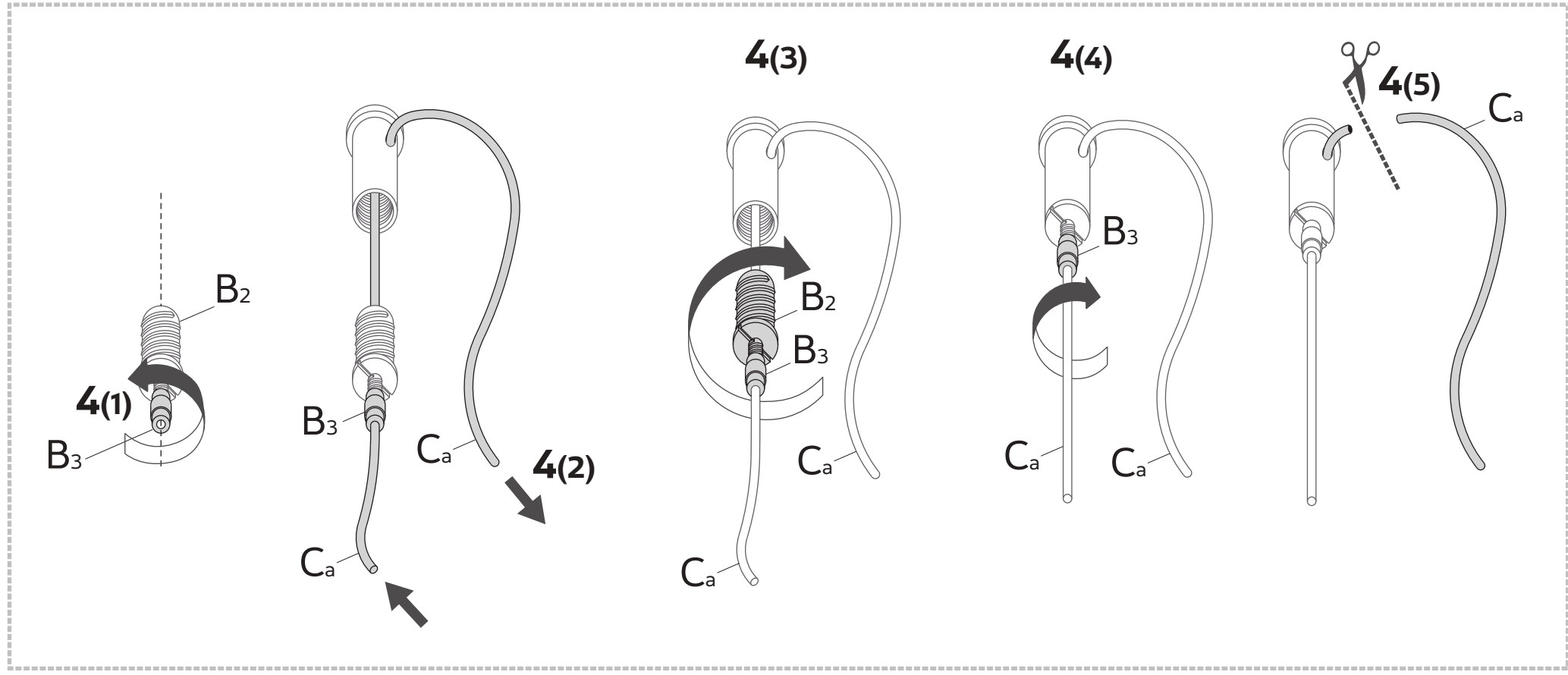
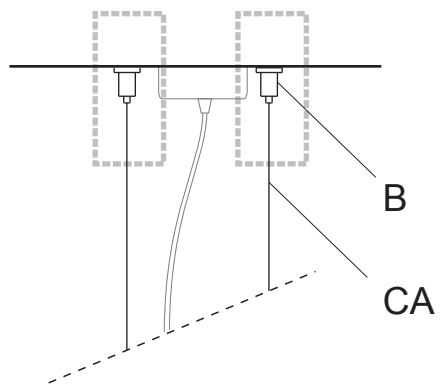

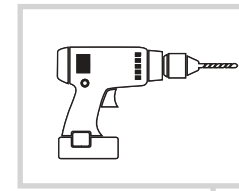
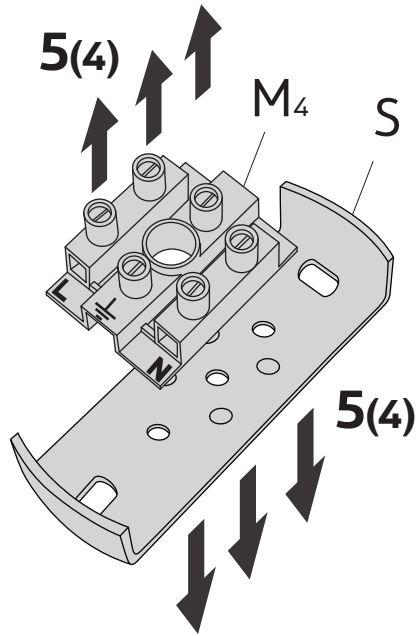
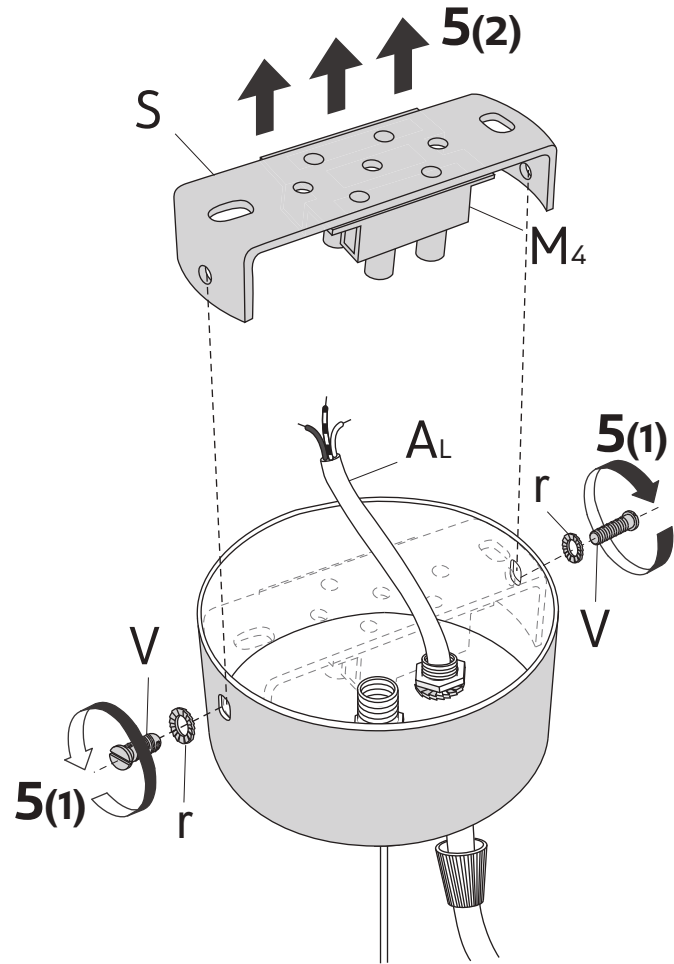
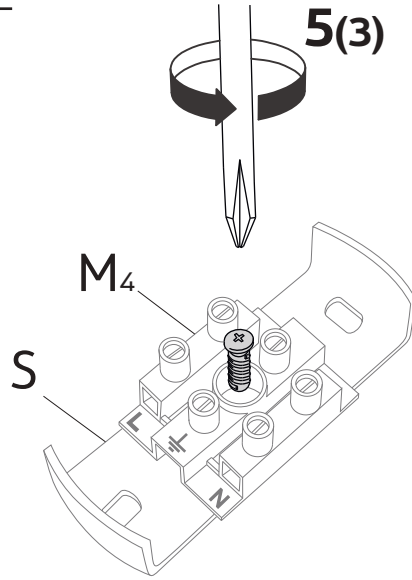
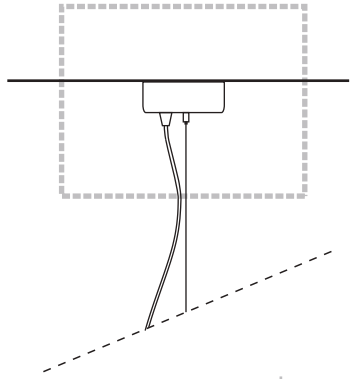
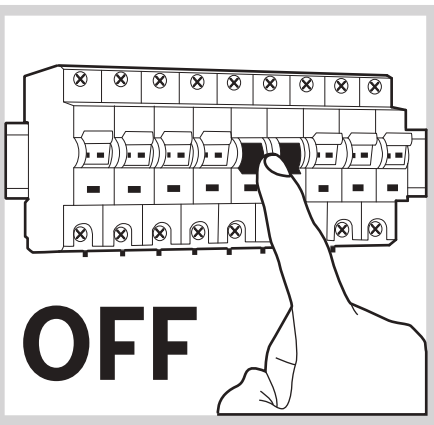

5

